

Nickel Plated Chain (N)



Specialized nickel plating for a neat and clean appearance and corrosion resistance

The surface of Rustless Chains is nickel plated for an appealing exterior and corrosion resistance. It will exhibit excellent corrosion resistance especially when used in combination with grease lubrication. You can expect the effect to delay hydrogen brittle destruction when used in circumstances where chains are exposed to sea breeze or acidic sprays.

Features

- The chain is protected even when in use with gilding or alumite machines that emit corrosive steam. The effectiveness of rust resistance and corrosion resistance of the nickel plating does not deteriorate even under conditions of high temperature and continues to protect the chain.
- The chain's fine exterior makes it ideal for machines for demonstration.

Recommended uses

- When a clean appearance is preferable
Food sanitation machines, office machines, textile machines, printing machines, pulp processing machines etc.
- When using in a corrosive environment
Chemical machines, gilding machines, alumite machines
- When a neat exterior is necessary
Demonstration machines at exhibitions etc.

Results of CASS test

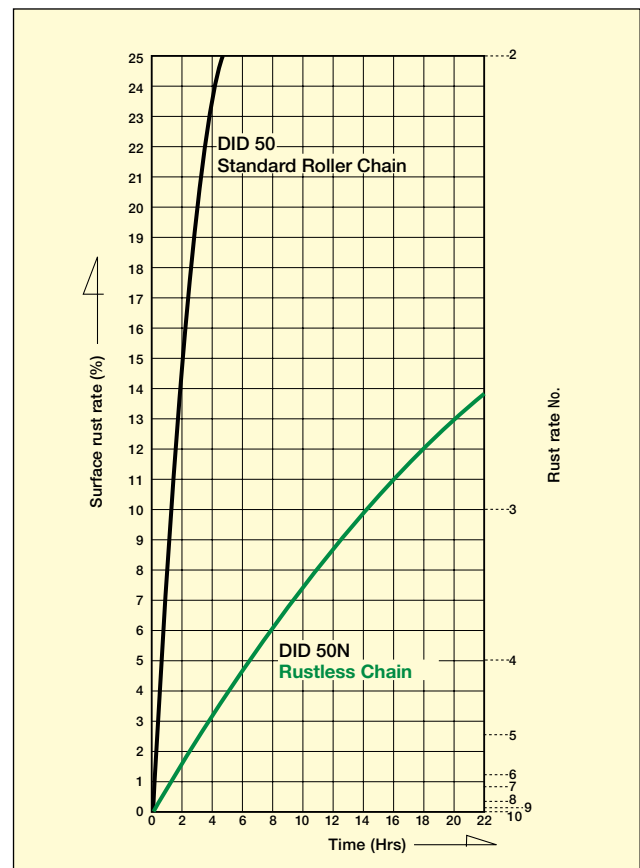

(Tested by DAIDO)



Selection of chains

The strength of Rustless Chain is equivalent with standard roller chains. For chain selection, refer to P120-122.

Connecting links and offset links

R connecting links are used for Rustless Chains #60 or smaller and C connecting links for #80 or larger. We provide 2POJ offset links for sizes #25 and #35, and OJ and 2POJ for all other sizes.

Sprockets

Standard sprockets for Rustless Chains can be used since the dimensions are the same as standard roller chains.

Caution

- ① Please use stainless steel chains when the chains are to be constantly exposed to water, sea water, liquid solutions or corrosive solutions.
- ② Unless wot so specified by the customer, chains are coated with grease before delivery. Please use the recommended lubricant (p.132) for the maintenance of the chain since lubrication using grease can cause lubrication failure.
- ③ Consult us if the chain is to be used for hoisting applications.

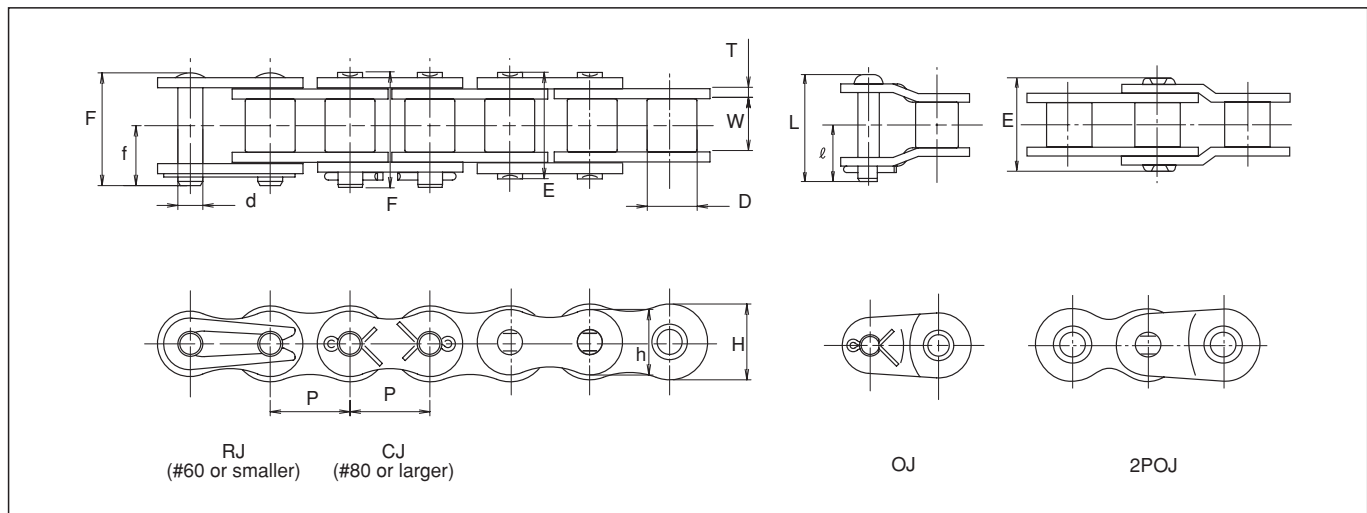

Dimensions

Unit (mm)

Chain No.	Pitch P	Roller link width W	Roller (Bush) dia. D	Pin						Plate			Avg. tensile strength		Max. allowable load		Approx. weight (kg/m)
				d	E	F	f	L	ℓ	T	H	h	kN	kgf	kN	kgf	
* DID 25N	6.35	3.18	(3.30)	2.31	7.8	8.5	4.7	—	—	0.72	5.9	5.20	4.41	450	0.73	75	0.13
* DID 35N	9.525	4.78	(5.08)	3.59	12.0	13.1	7.3	13.9	7.8	1.25	9.0	7.75	11.2	1,150	2.15	220	0.32
DID 41N	12.70	6.38	7.77	3.59	13.7	14.6	7.9	15.3	8.6	1.20	9.6	8.00	10.7	1,100	2.35	240	0.39
DID 40N	12.70	7.95	7.92	3.97	16.5	17.6	9.5	19.3	10.6	1.50	12.0	10.40	19.1	1,950	3.72	380	0.63
DID 50N	15.875	9.53	10.16	5.09	20.3	21.9	11.6	23.1	12.1	2.00	15.0	13.00	30.9	3,150	6.86	700	1.06
DID 60N	19.05	12.70	11.91	5.96	25.4	26.9	14.3	30.0	15.7	2.40	18.1	15.60	44.1	4,500	9.31	950	1.44
DID 80N	25.40	15.88	15.88	7.94	32.6	35.4	19.0	36.4	19.5	3.20	24.0	20.80	78.4	8,000	14.7	1,500	2.55
DID 100N	31.75	19.05	19.05	9.54	39.5	42.5	22.8	43.5	23.5	4.00	29.9	26.00	118	12,100	22.5	2,300	3.79
DID 120N	38.10	25.40	22.23	11.11	49.7	53.0	28.2	54.1	28.2	4.80	35.9	31.20	166	17,000	30.4	3,100	5.49
DID 140N	44.45	25.40	25.40	12.71	53.6	58.4	31.6	59.6	31.7	5.60	41.9	36.30	215	22,000	40.2	4,100	7.11
DID 160N	50.80	31.75	28.58	14.29	63.6	68.2	36.4	69.7	36.5	6.40	47.8	41.40	269	27,500	52.9	5,400	9.82

Note: Those marked with * indicate bushing chains.